

Assembly Instructions for - 37170

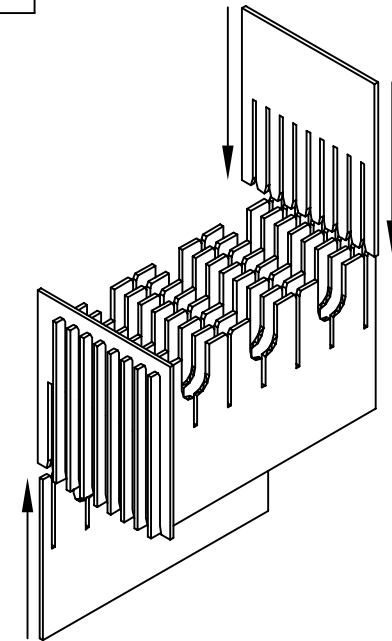
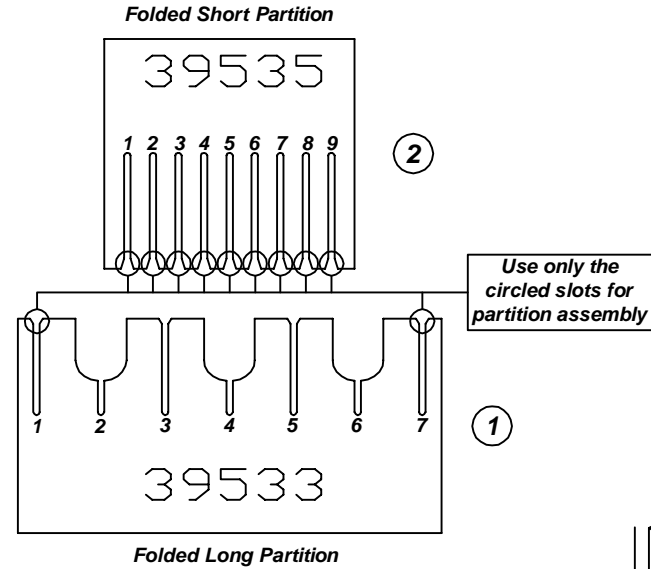
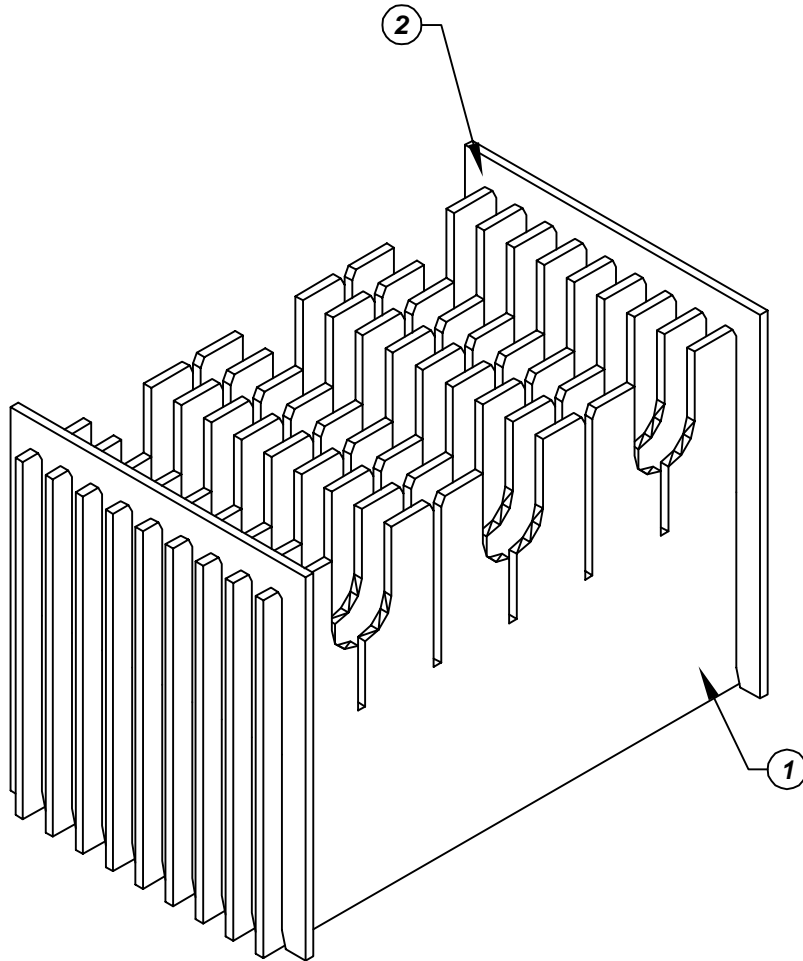

Made in America

F/N ①	Part # 39533	Dimensions: 20-7/8" x 16-5/8"	Description: 402-LP Long Partition	Qty: 9
F/N ②	Part # 39535	Dimensions: 22-3/8" x 9-13/16"	Description: 402-SP Short Partition	Qty: 2

37170 - 10 Cell Inplant Handler
Cell Size - 11-1/4" x 14-3/4" x 3/4"

Notes:
 For use with the following storage container & lid:
 37502 - Storage Container
 37550 - Lid

PROTEKTIVE PAK
 13520 MONTE VISTA AVENUE, CHINO, CA 91710
 PHONE (909) 627-2578, FAX (909) 363-7331
 ProtektivePak.com



DRAWING NUMBER
IPH-37170

DATE
 Dec.
 2007